

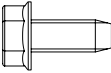









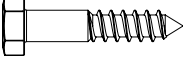



# NOTICE COMPLÈTE D'INSTALLATION KIT ANTI-EFFRACTION



<b>A</b>		<b>150102</b> <b>DIN 7500D M8x20</b>		
<hr/>				
		<b>DIN 571 8x40</b>		
		<b>DIN 125 - A 8,4</b>		
		<b>10x50</b>		
<b>B</b>		<b>14023</b> <b>M8 x 17</b> <b>Ø 17 mm</b>		
<b>C</b>		<b>14022</b> <b>M8</b> <b>10 Nm</b>		

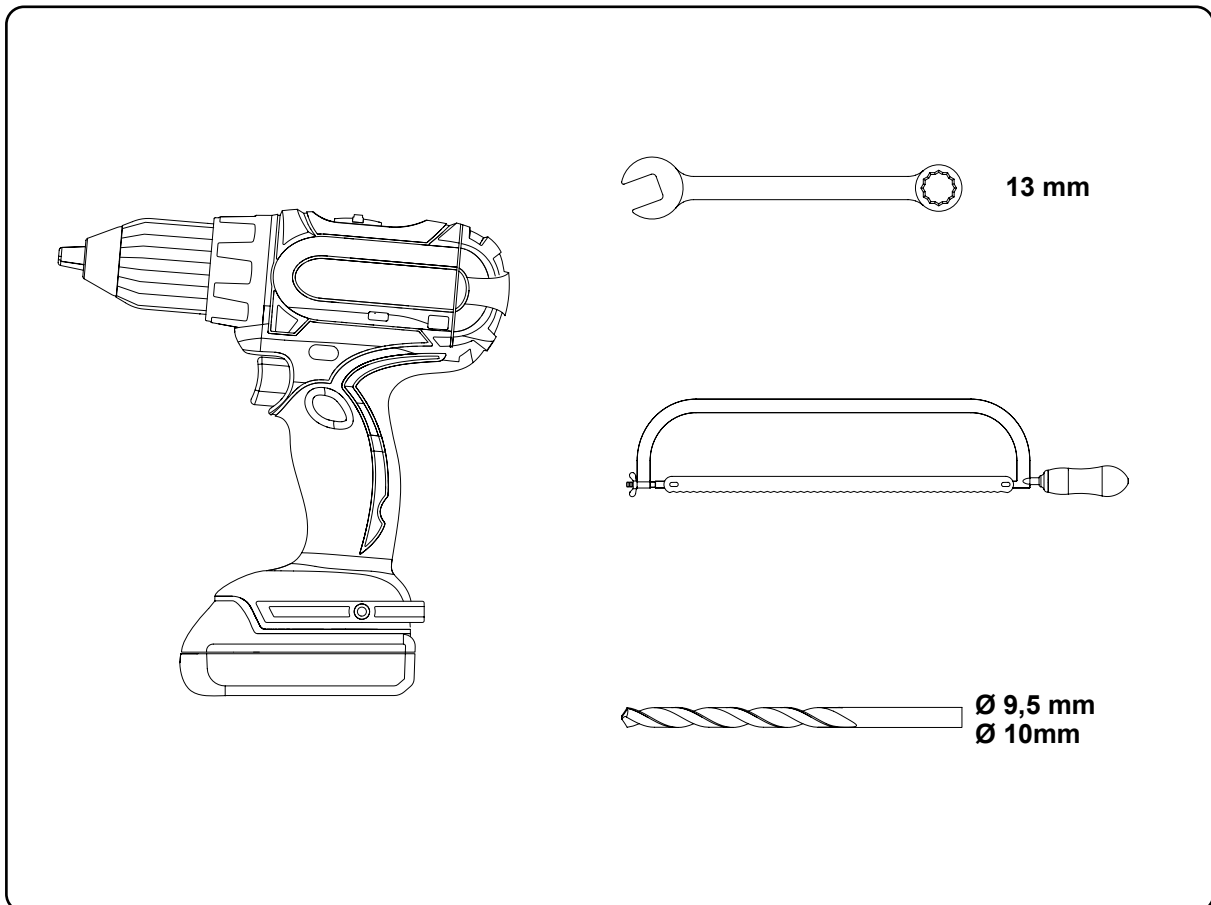

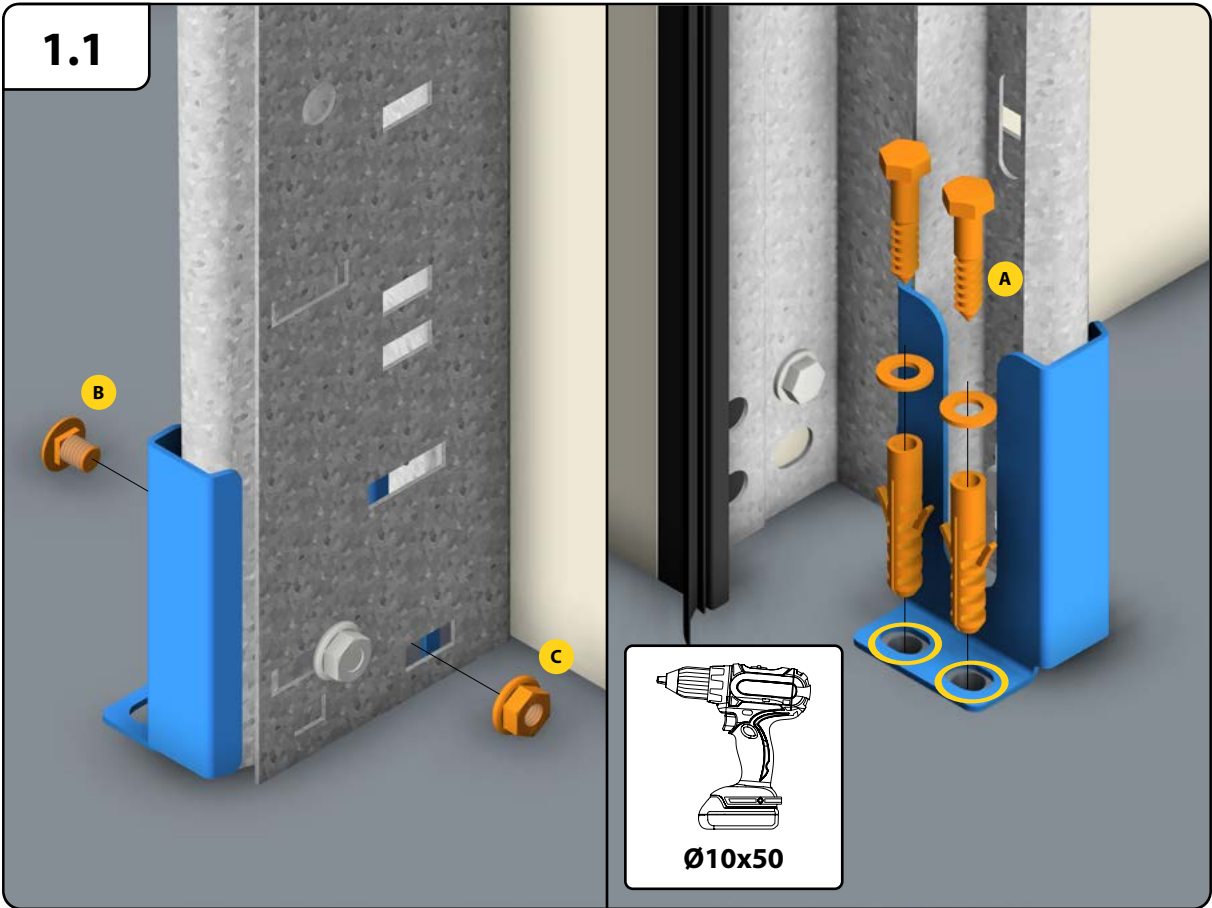
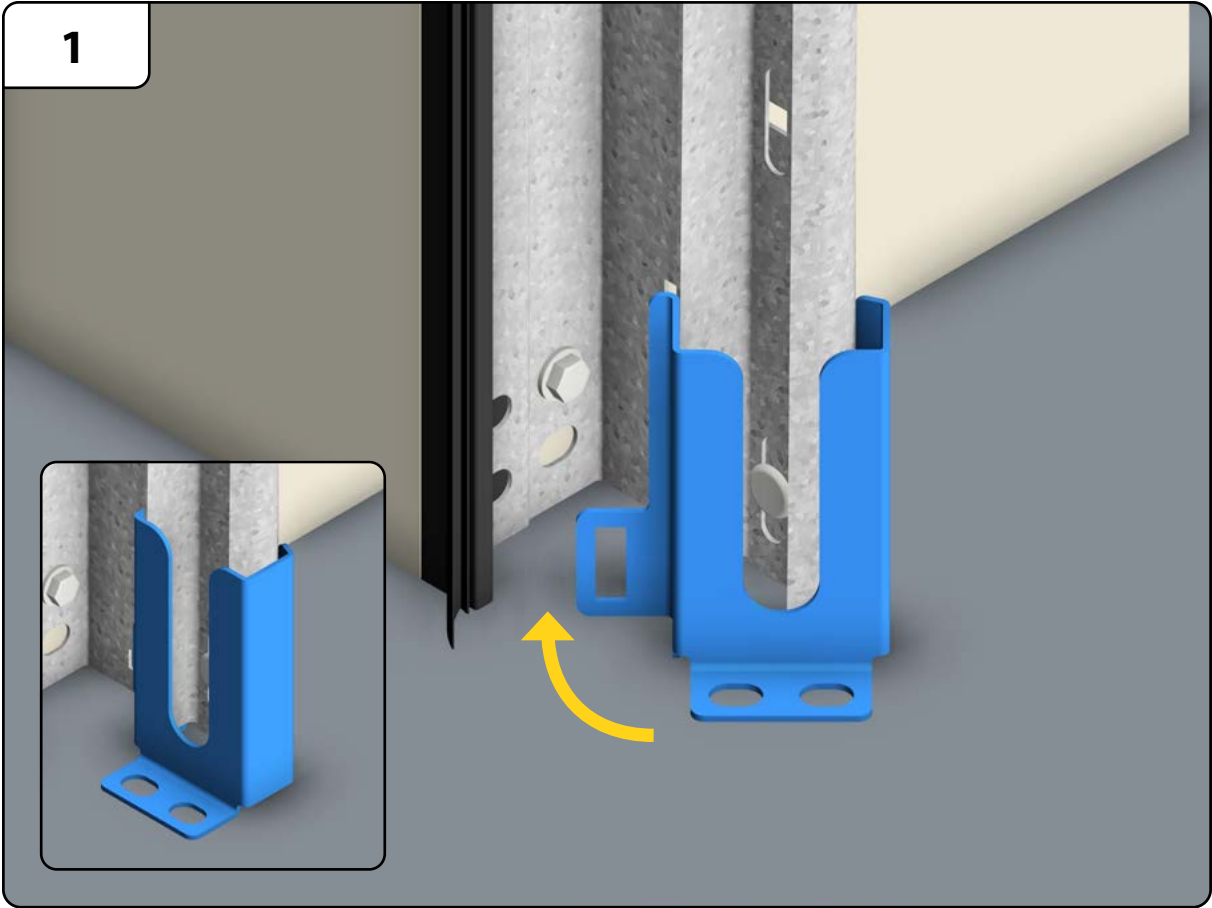

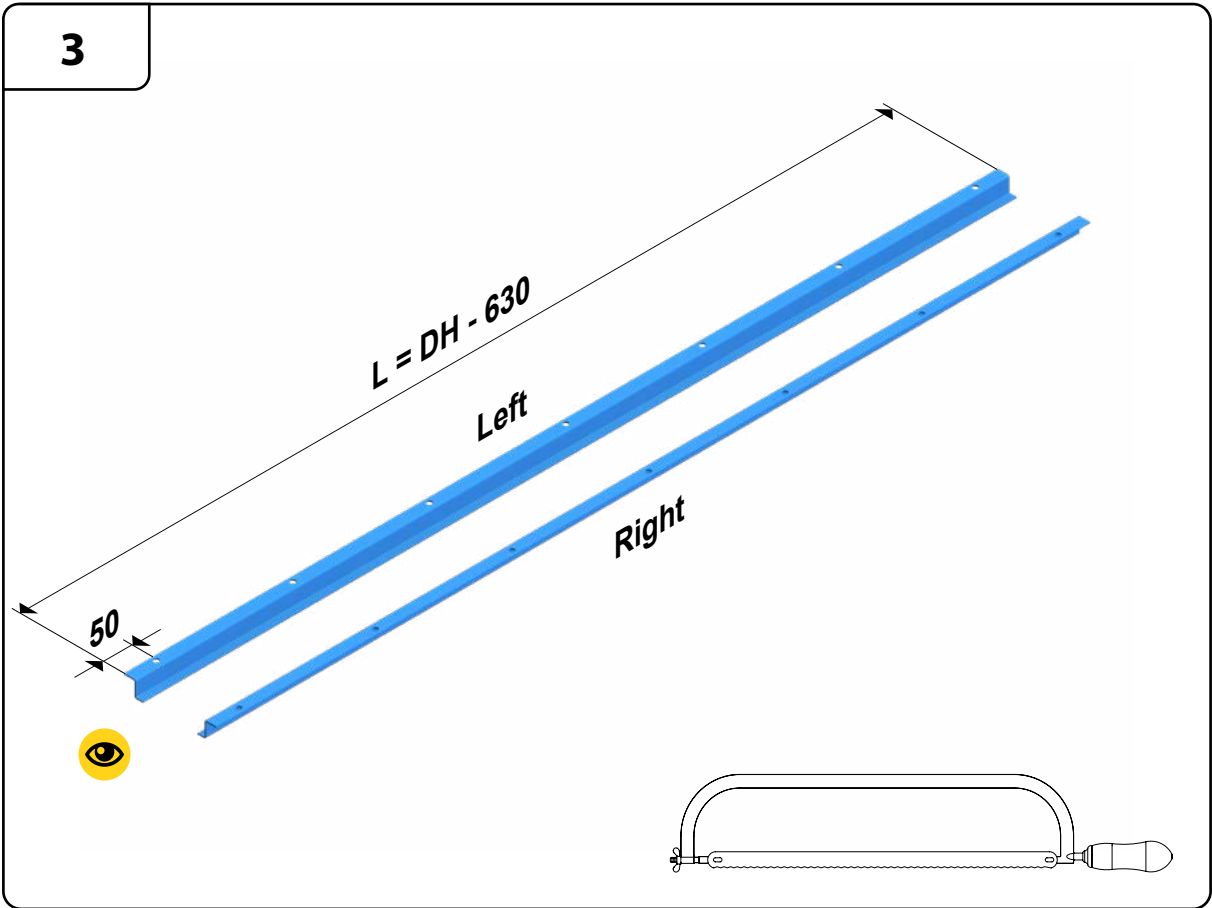
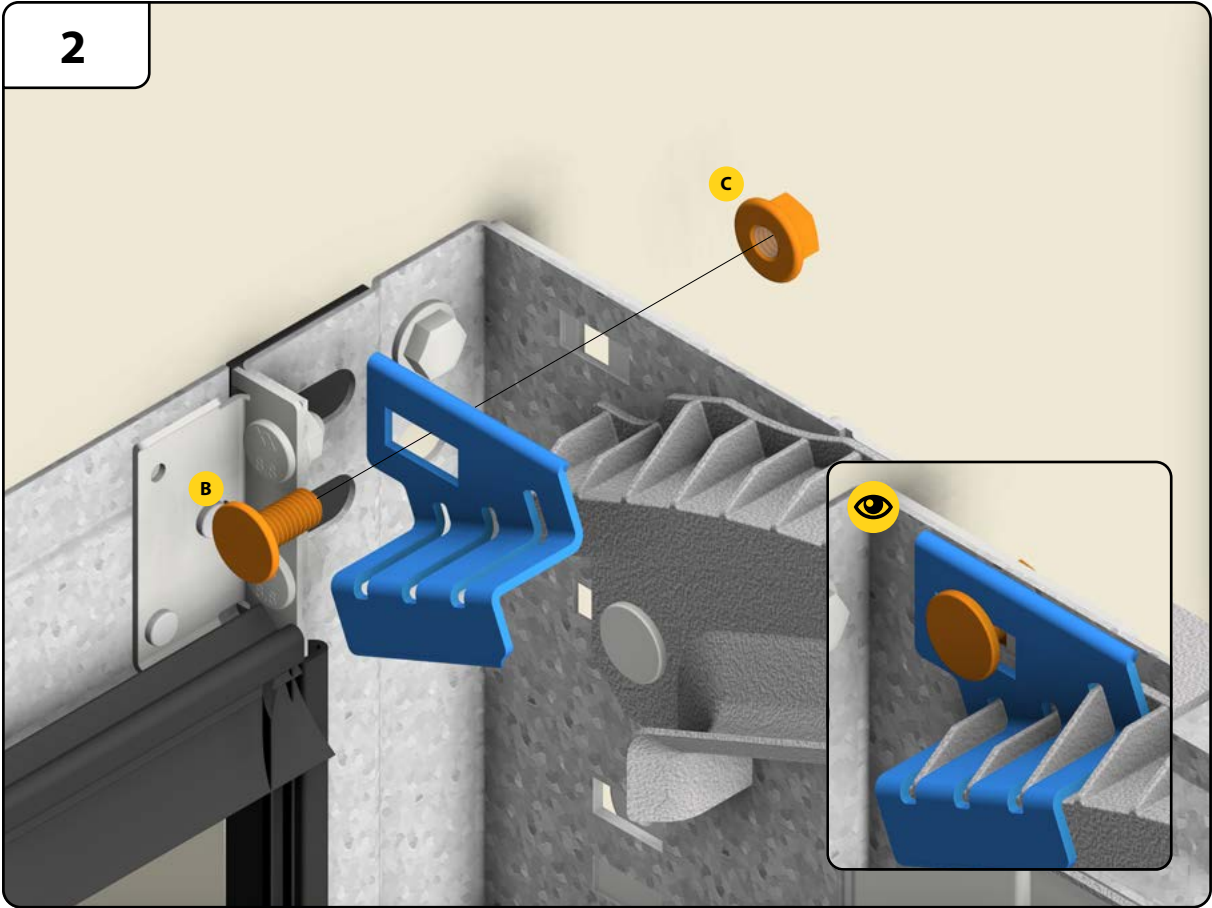

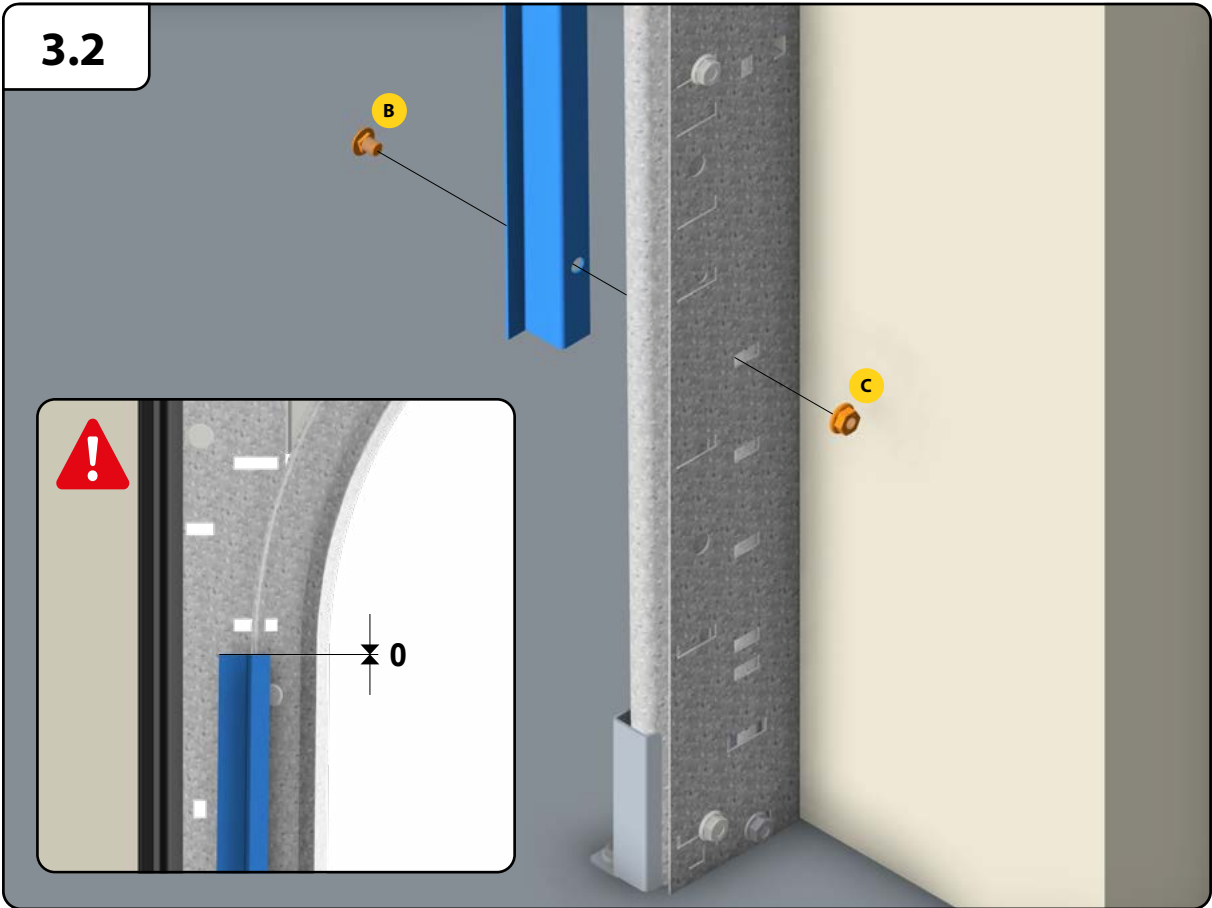
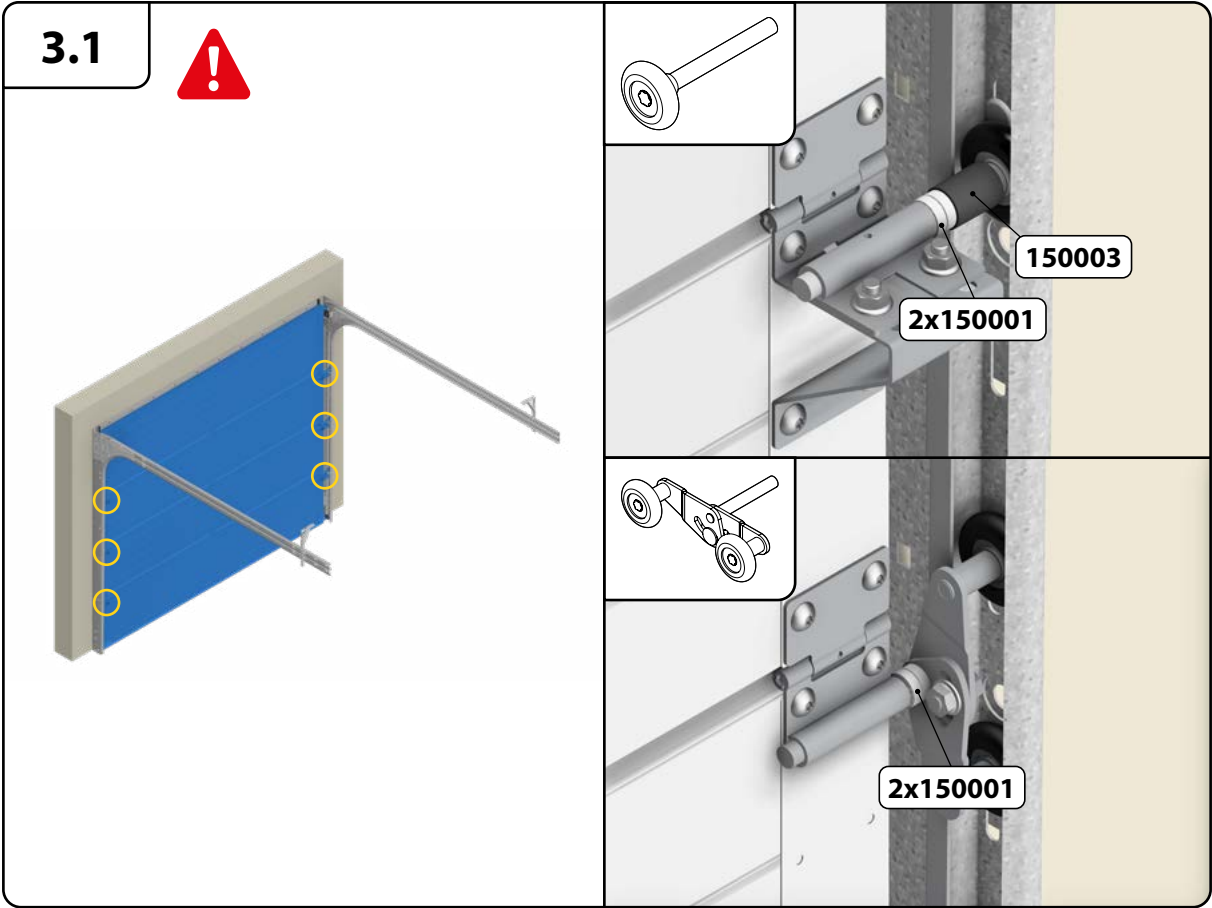

**3.3**

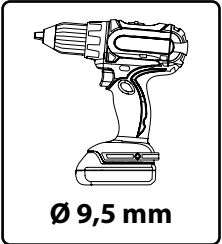
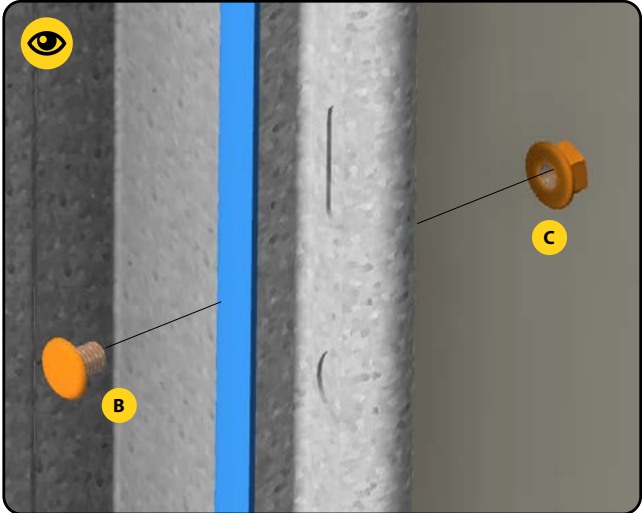
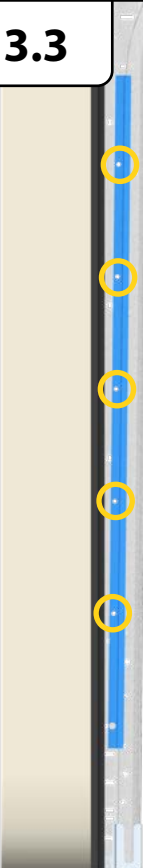

**Ø 9,5 mm**